

ASSEMBLY AND INSTALLATION INSTRUCTIONS

C0184

WARNING : TO AVOID RISK OF ELECTRICAL SHOCK ,BE SURE TO SHUT OFF POWER BEFORE INSTALLING OR SERVICING THIS FIXTURE .

NOTES: 1. Before installing ,consult local electrical codes for wiring and grounding requirements
2. READ AND SAVE THESE INSTRUCTIONS

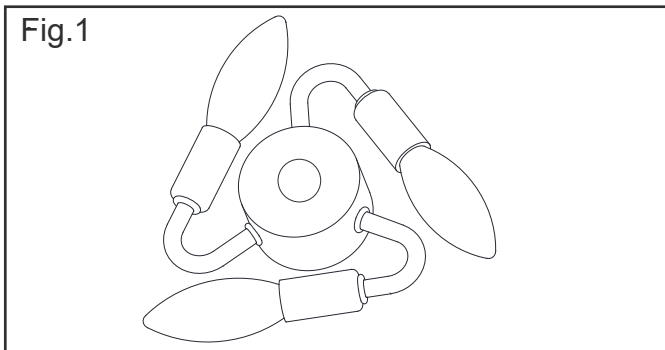
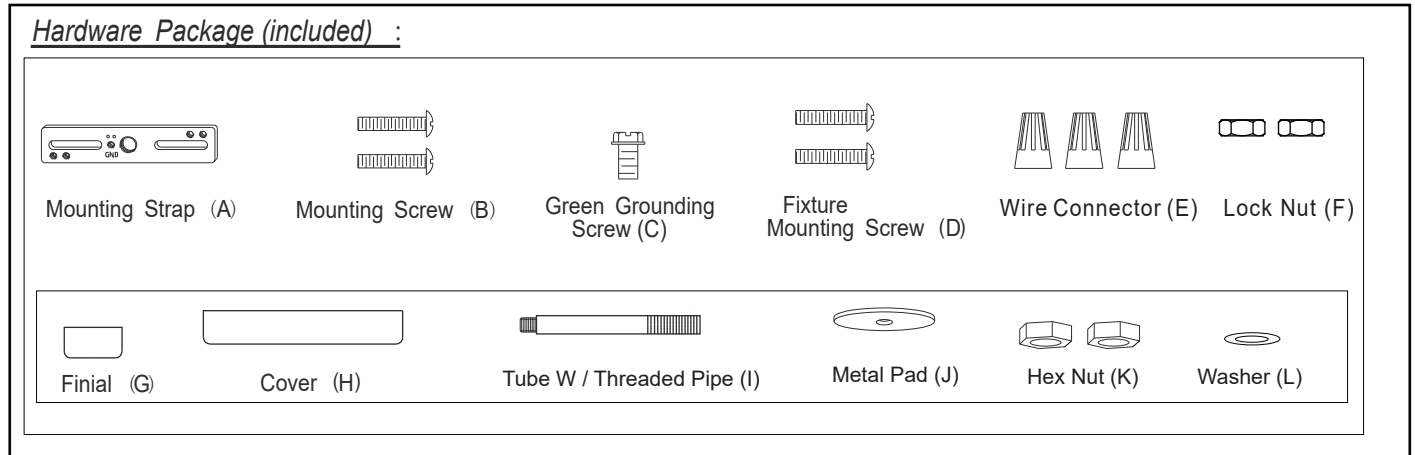

Installation Steps

Turn off the power at fuse or circuit box

1. Attach the two fixture mounting screws to the holes on the mounting strap, and screw them in 2 to 3 turns.
2. Attach the mounting strap to the outlet box using two mounting screws.
3. Pull out the source wires from the outlet box. Make wire connections using wire connectors as follows:
 - Connect the hot wire (usually black insulation) from the fixture to the black wire from the power source.
 - Connect the neutral wire (usually white insulation) from the fixture to the white wire from the power source.
 - Attach the fixture grounding wire (usually green insulation or bare wire) to the mounting strap with the green grounding screw, and then connect it to the house grounding wire with the wire connector.
 Carefully put the wires back into the outlet box.

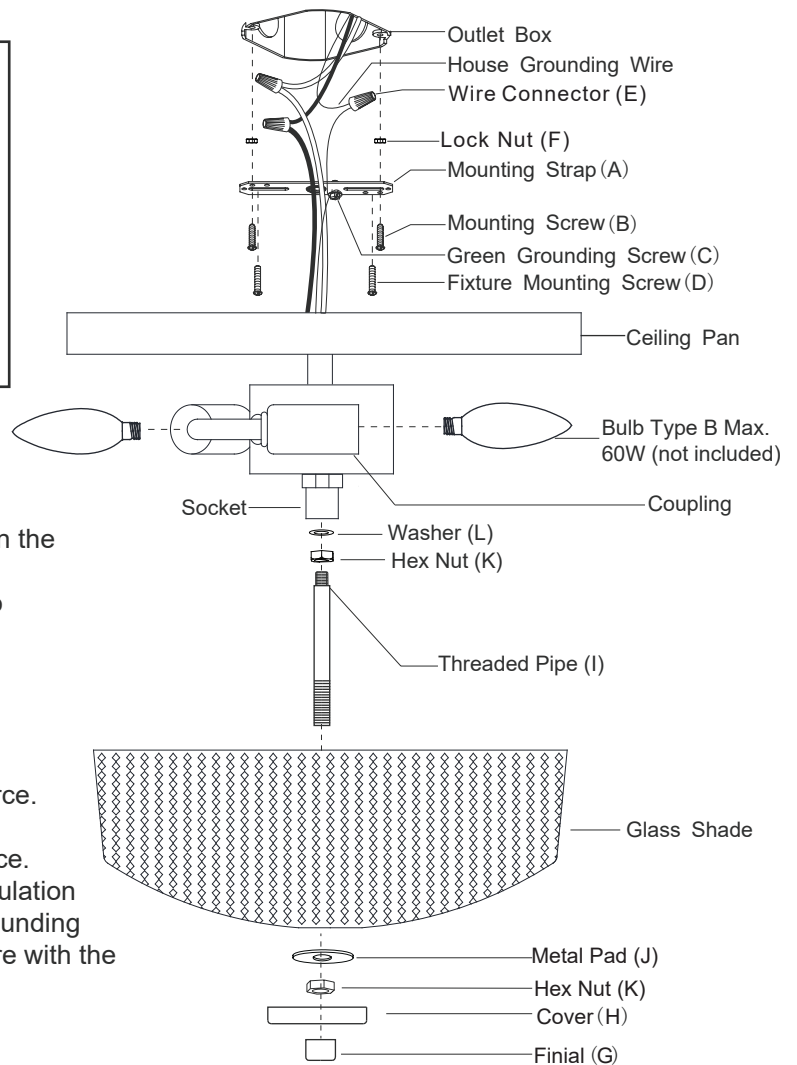











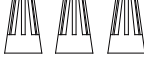

4. Attach the ceiling pan to the mounting strap by inserting two fixture mounting screw heads into the key hole, and rotate the pan until it is locked in place. Then secure the screws tightly.
(See Fig.1)
5. Screw the tube with the threaded pipe head into the coupling until tightened.
6. Install bulbs (not included), See relamping label at socket area or packaging for maximum allowed wattage.
7. Secure the nipple into the tube. Adjust the nipple to the suitable location.
8. Attach the glass shade to the pan by inserting the nipple and tighten it with metal pad and hex nut.
Note: Do not over tighten, breakage of glass shade could be occurred.
9. Slip the cover up through the nipple secure it with a finial.

Turn on the power at fuse or circuit box

The following parts are available for re-order if damaged or missing.

Spare Parts List :

						→ Mounting Hardware 5854MM (1SET)
Mounting Strap (A)	Mounting Screw (B)	Green Grounding Screw (C)	Fixture Mounting Screw (D)	Wire Connector (E)	Lock Nut (F)	
						→ Mounting Hardware 5855MM (1SET)
Finial (G)	Cover (H)	Tube W / Threaded Pipe (I)	Metal Pad (J)	Hex Nut (K)	Washer (L)	

Glass Shade
X1
9860CT

